

FORWARD 2025



WHO WE ARE	4
PRODUCTS	8
New Laser Blade / New Laser Blade XS	10
Tack	16
Sipario	20
Newfo	26
Underscore	30
Ribeira	32
Lander	38
Billboard	42

**Together,
we light busy cities, quiet entry ways, museum
halls, iconic monuments, great works of art,
extraordinary architectural structures, historic
buildings, shopping and retail experiences,
and remarkable living and working spaces
around the world. We light the future.
Creating environments that are inspiring, safe,
smart, revolutionary, creative and feel like home.**

**We are iGuzzini.
Our vision is Social Innovation. Creating more
habitable, sustainable, awe-inspiring spaces
for people everywhere.
We create light that moves.
Light that moves spaces. Light that moves culture.
Light that moves ideas. Light that moves people.
Light that moves us forward.**

**LIGHT
THAT MOVES**



We are a global design partner dedicated to building the **culture of light through innovation, connectivity, and sustainability**

we are driven by

TECHNICAL CONSULTING

Our lighting knowledge at the service of your vision

BESPOKE

From design and development to production and on-site support

Our service approach

GLOBAL NETWORK

- 1200 employees 65 nationalities
- 45 offices 3 production sites worldwide
- 139 international partners

Together we light the future

We improve the quality of life through light that applies to your projects in:

RETAIL

INFRASTRUCTURE

CULTURE

URBAN

WORKING

HOSPITALITY
& RESIDENTIAL

By creating Indoor and Outdoor **SMART LIGHTING SOLUTIONS.**

Providing unique lighting solutions for spaces and people everywhere.

PRODUCTS

The 2025 new releases reflect who we are: a balance between aesthetics and performance, between a passion for design and technological innovation, serving those who shape light and spaces.

Each new solution stems from the evolution of our know-how, offering ever better and more efficient performance, adaptable to any space, both indoor and outdoor. The collections are coordinated to offer visual continuity and design freedom: connected systems designed to integrate naturally into different environments, while maintaining aesthetic consistency and functionality.



NEW LASER BLADE NEW LASER BLADE XS

The icon sets new standards

design iGuzzini

Laser Blade has revolutionised the concept of downlighting, liberating light without revealing the source. With its minimalist design and outstanding performance, it has become an icon in professional lighting, combining aesthetics and functionality. Its success lies in the miniaturised Optibeam optic, offering high visual comfort and a perfectly defined circular light beam, free from chromatic imperfections. Innovation continues with luminous efficiency reaching up to 124 lm/W, delivering even more intense and uniform distribution in models such as Laser Blade and Laser Blade XS. Laser Blade creates a visual magic, transforming an invisible line into a luminous circle that redefines the interaction between space, light and design. Laser Blade XS is a symbol of miniaturisation and precision, bringing light from the ceiling. 35.000+ projects and 20+ awards worldwide.

EFFICIENCY UPGRADE UP TO 124 lm/W

LASER BLADE

UP to 120 lm/W
 FIX 1 | 2 | 3 | 5 | 10 | 15 | cells
 ADJ 1X10 | 1X15 | 2X10 | 2X15 | cells
 Space optic 5 cells
 Recessed
 S | MOL | MOT | F | WF | WOT | WOL |
 GLPRO | WW | WWLGC
 2700K | 3000K | 3500K | 4000K | TW
 CRI 80 | CRI 90 | CRI 95
 From 160 to 3500 lm
 DALI-2
 1 | 2 cells Class III

EVEN MORE POWERFUL AND HOMOGENEOUS LIGHT DISTRIBUTION

LASER BLADE XS

UP to 124 lm/W
 FIX 1 | 2 | 3 | 5 | 10 | 15 | cells
 ADJ 1X10 | 1X15 | 2X10 | 2X15 |
 1X5 | 2X5 cells
 Recessed | Ceiling | LV track | Filorail |
 Superrail | Pendant
 M | F | WF | GL | WW | WWLGC
 2700K | 3000K | 3500K | 4000K | TW
 CRI 80 | CRI 90
 From 170 to 3100 lm
 DALI-2
 1 | 2 | 3 | 4X cells Class III

PATENTED INNOVATION

INVISIBLE SOURCE, MAXIMUM COMFORT

Intelligent Light Solutions

Smart Control: Organic Response |
 Quick BLE (Casambi) | Quick DALI |
 Master Pro EVO
 Smart Services: Space Management |
 Push Notification



Available from June 2025















An invisible soul with even more astonishing performance: we've elevated its essence to the fullest, evolving the legend. It's the future that chases it.





LASER BLADE

- | | |
|---|--|
|  WHITE |  WHITE BLACK |
|  BLACK |  WHITE TRANSPARENT |
|  CLEAR TRANSPARENT |  WHITE GOLD |
|  BLACK BLACK |  GREY BLACK |
|  BLACK TRANSPARENT |  WHITE BURNISHED CHROME |

LASER BLADE XS

- | | |
|---|---|
|  WHITE |  GOLD |
|  BLACK |  GREY BLACK |
|  BLACK BLACK |  BURNISHED CHROME |
|  WHITE BLACK |  WHITE BURNISHED CHROME |
|  WHITE GOLD | |



Laser Blade



Laser Blade XS



Other awards:
Lux Award 2012, German Design Awards 2015, DARC Awards,
Best Architectural Lighting product interior 2015



TACK

Shaping performance

design iGuzzini

Tack is the spotlight designed for retail spaces, combining essential design with outstanding performance. Equipped with two optics – reflectors and lenses – it offers precision, comfort, and efficiency up to 160 lm/W. Available in three sizes, it features a manual switch on the rear that allows for easy on-site adjustment of light output across three power levels to achieve the desired effect. A graduated scale ensures precise aiming and long-term stability. Compatible with two accessories simultaneously, Tack can be installed on track, both horizontally and vertically, or on dedicated surface-mounted or recessed bases. Maintenance is simplified thanks to the possibility of replacing the driver and LED module both from the front and the rear, ensuring long-lasting durability.



EFFICIENCY
UP TO 160 lm/W

THREE-LEVEL
POWER SWITCH

REFLECTORS/LENSES,
MULTIPLE ACCESSORIES

EASY REPARABILITY

TACK

Ø60 | Ø80 | Ø90 mm

Lens and reflector

S | M | F | WF

3000K | 3500K | 4000K

CRI 90

Ø60 up to 1800 lm

Ø80 2000 lm | 2500 lm | 3000 lm *

Ø90 3000 lm | 3500 lm | 4000 lm *

Up to 160 lm/W

ON-OFF

DALI-2

* manual power switch

Intelligent Light Solutions

Smart Control: Organic Response | Quick BLE (Casambi)
Quick DALI | Master Pro EVO

For MV Track: Organic Response sensor | Casambi sensor

Smart Services: Space Management | Push Notification



Available from June 2025





SWITCH POWER

Up to three power levels with the same product (for Ø80 | Ø90 mm versions).

DOUBLE OPTICAL TECHNOLOGY

Reflectors and lenses for optical versatility and excellent performance.

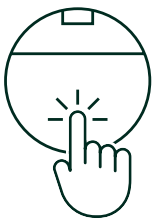

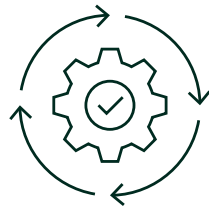

PUSH-PULL FOR DRIVER EXTRACTION

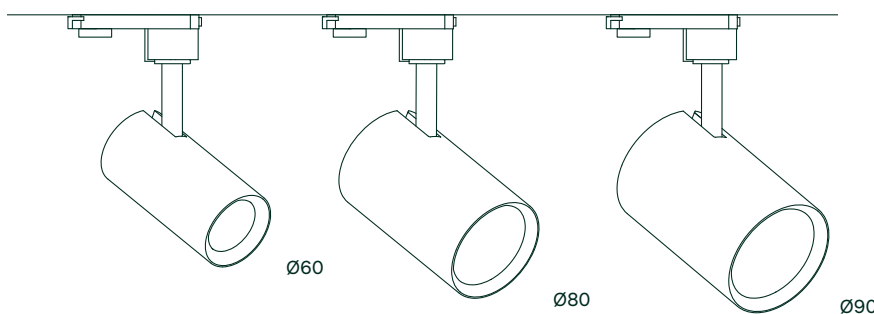

SIMPLIFIED MAINTENANCE AND REPAIR

Tack will also be available in recessed and pendant versions.



-  WHITE
-  BLACK



PRECISION AND EASY REPAIRABILITY

Up to two accessories at the same time.
Graduated scale. Easily replaceable driver
and LED circuit.





SIPARIO

Low Voltage

design iGuzzini

Sipario evolves with new low-voltage track versions and miniaturised sizes, expanding the possibilities of a professional and future-proof spotlight. Lightweight, sustainable, and easily disassemblable, it is made with mass-balanced, recycled, and recyclable materials. Maintenance is simplified thanks to front and rear access. Patented Optibeam optics, lenses, reflectors, and refractors are interchangeable via the Push&Go system (*patent pending*), ensuring high efficiency and low energy consumption. It supports up to three internal accessories and one external. Available in track-mounted, recessed and surface-mounted versions, and with a horizontal arm for wall applications. Equipped with DALI Powerline or Casambi technologies, also with sensor integration and smart features such as push notifications. With Sipario Low Voltage, a complete family of highly professional projectors is born - available in various sizes, powers, optics, distributions, and technologies.

MINIATURISATION

EASY REPLACEMENT

PUSH&GO SYSTEM (PATENT PENDING)

SMART SENSOR (FOR TRACK USE)

SIPARIO LOW VOLTAGE

Ø22 | Ø40 | Ø56 | Ø73 | Ø86

S | M | F | WF | VWF | WW | O

Opti beam Lens | Opti Beam Reflector

2700K | 3000K | 3500K | 4000K

CRI 90 | Trigain CRI 90 | CRI 97

From 100 to 2400 lm

Up to 122 lm/W

DALI Powerline

CASAMBI

For recessed and surface

Class III

ON-OFF

1-10 V

DALI

Intelligent Light Solutions

Smart Control: Quick BLE (Casambi)

Quick DALI | Master Pro EVO

For LV Track: Casambi sensor

Smart Services: Push Notification

In addition for recessed and surface:

Smart Control: Organic Response

Smart Services: Space management

SIPARIO LV: available from September 2025





2015—
2016

Architectural
Allusions

Text describing the architectural allusions of the objects in the 2015-2016 section.

1700—
1800

Engraved Glass
of the Lagoon

Text describing the engraved glass of the Lagoon.



PRECISION CONTROL

Manual dimmer and graduated bracket allow fine-tuning of the perfect effect.



PATENTED OPTIBEAM TECHNOLOGY

Optibeam lenses, reflectors and refractors, interchangeable with Push&Go system (*patent pending*).

Low Voltage Track

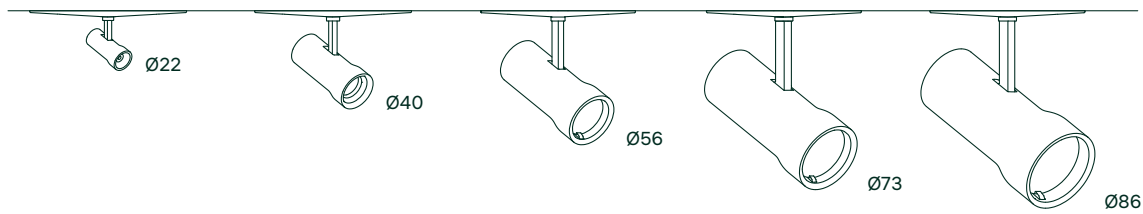

LV Surface

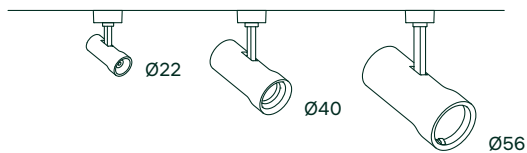

LV Recessed

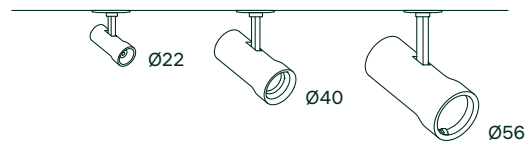

MINIATURISED PROFESSIONALITY
Up to four accessories simultaneously.
Easily replaceable driver and LED circuit.

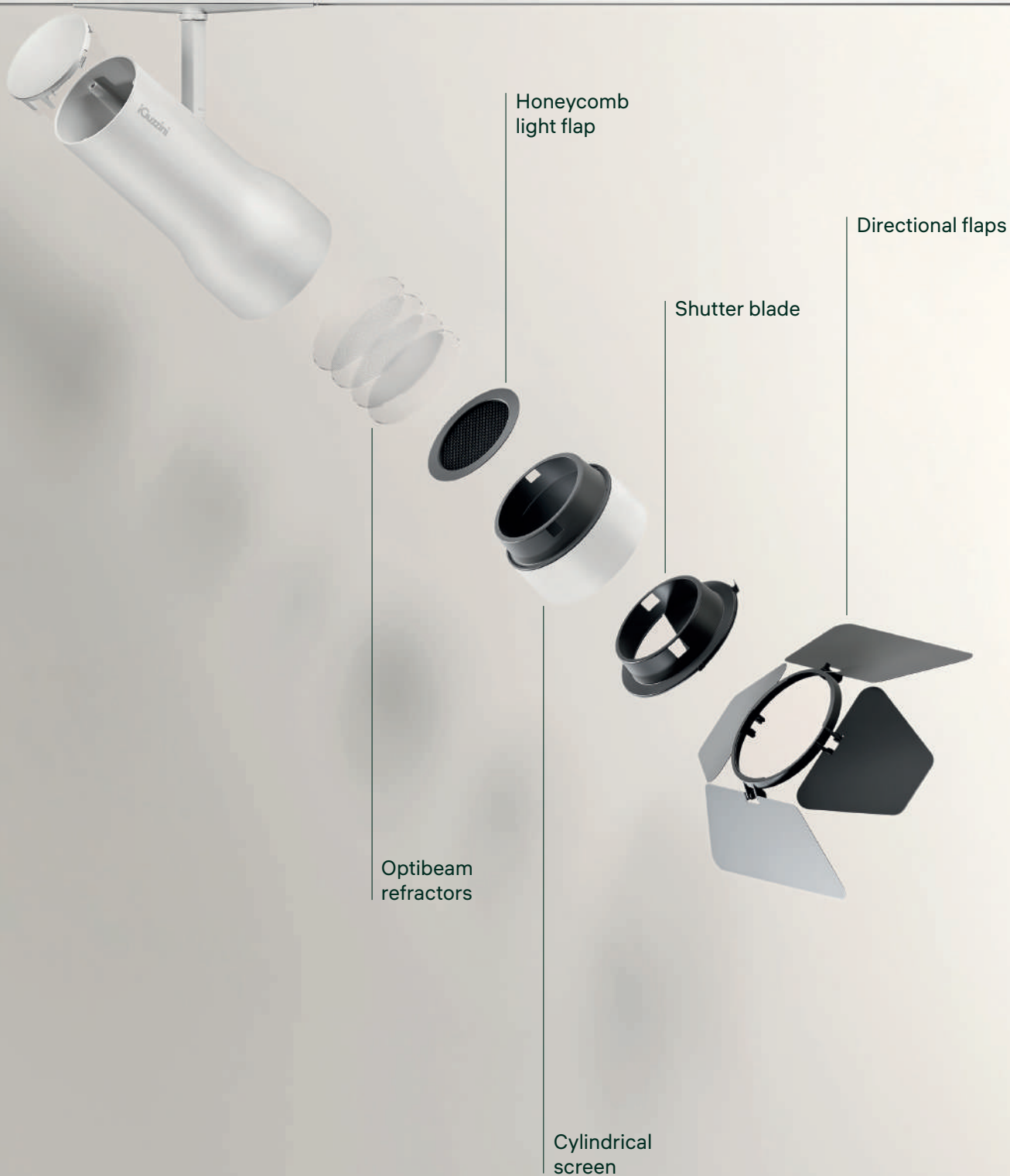

Overview
SIPARIO MV
SIPARIO LV



Sipario MV – TW / Manual dimmer:
available from June 2025

Sipario LV



Sipario MV





NEWFO

New versions: all tracks

Lightweight, functional, and contemporary, Newfo was originally developed for the LV Filorail track and now adapts to all tracks – both mains voltage and low voltage – thanks to compatibility with DALI-2, DALI Powerline, or Casambi adapters. It can be installed as a spotlight or suspended with a dual cable, expanding its range of applications across all types of environments. Despite its recent launch, Newfo has already earned design awards, standing out as a symbol of technological and emotional lighting. Inspired by the iconic 1977 Ufo spotlight, Newfo embraces “squircle” shapes while preserving the original's iconic features. With the patented Optibeam optic, lenses and refractors are interchangeable through the Push&Go system (*patent pending*), offering maximum flexibility. The Casambi sensor enables precise light management.

design iGuzzini



SQUIRCLE DESIGN

NEWFO MAINS VOLTAGE

Ø88 | Ø116mm
 Projector | Pendant
 M | F | WF | VWF | WW | O
 Opti beam Lens | Opti Beam Reflector
 2700K | 3000K | 3500K | 4000K
 CRI 90
 From 1050 to 2500 lm
 Up to 114 lm/W
 DALI-2
 Casambi

OPTIBEAM REFLECTOR AND LENS

Intelligent Light Solutions

Smart Control: Organic Response | Quick BLE (Casambi) | Quick DALI | Master Pro EVO
For MV Track: Organic Response sensor | Casambi sensor
Smart Services: Space Management | Push Notification



COMPATIBLE WITH ALL LV & MV TRACKS

NEWFO LOW VOLTAGE

Ø62 | Ø88 | Ø116
 Projector | Pendant
 S | M | F | WF | VWF | WW | O
 Opti beam Lens | Opti Beam Reflector
 2700K | 3000K | 3500K | 4000K
 CRI 90
 From 490 to 2500 lm
 Up to 114 lm/W
 DALI Powerline
 Casambi

SMART SENSOR (FOR TRACK USE)

Intelligent Light Solutions

Smart Control: Quick BLE (Casambi) | Quick DALI | Master Pro EVO
For MV Track: Casambi sensor
Smart Services: Push Notification



Available from September 2025





PATENTED OPTIBEAM TECHNOLOGY

Optibeam lenses, reflectors and refractors, interchangeable with Push&Go system (*patent pending*).

PERFECT EFFECT

Internal and external accessories to finalise a precise and defined lighting effect.



Low Voltage Track

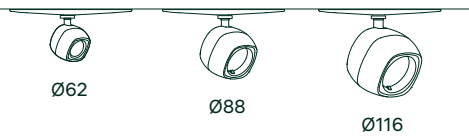

Mains Voltage Track

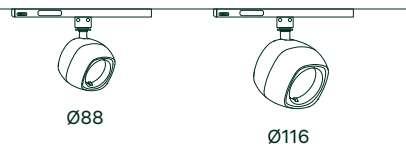

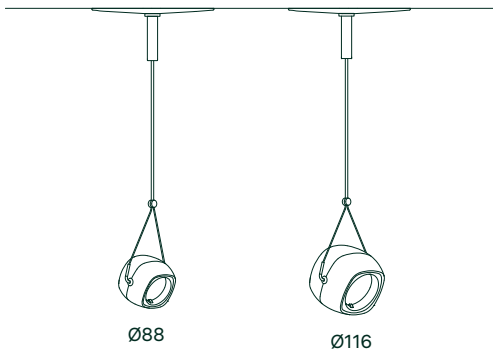

Low Voltage Track

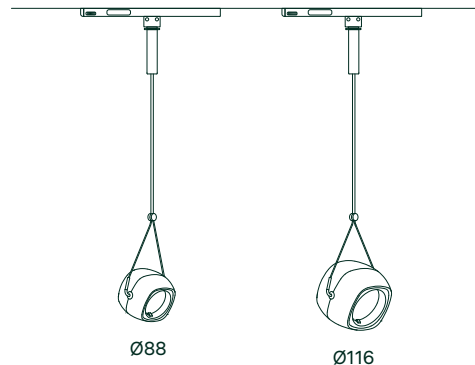

Mains Voltage Track



Body

-  WHITE
-  MATTE BLACK
-  TITANIUM

Front frame

-  BLACK
-  TITANIUM
-  BRASS
-  MATTE COPPER



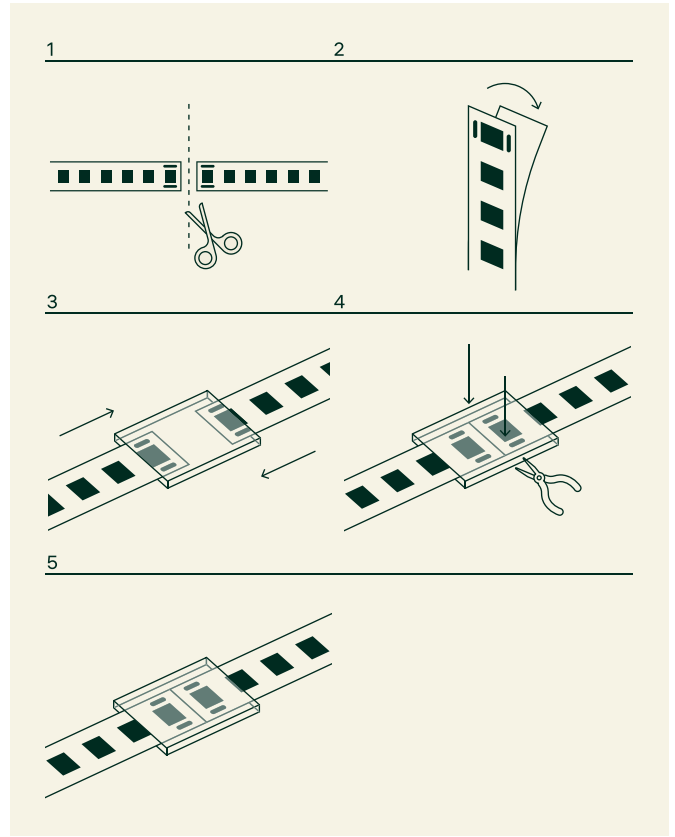

UNDERSCORE LEDSTRIP HP

Tube and fast connect

design iGuzzini

Underscore is the solution that reveals light where there would otherwise be shadowed areas. It is a complete and professional system designed to highlight pathways, create textures or shape architectural elements, in a dynamic way. Innovation continues with the aim of offering increasingly high-performance and user-friendly solutions, resulting in a reduction of installation costs. The new versions of Underscore Ledstrip 24V (high power) have been updated with more efficient LEDs. In addition, with the exception of the Tube models, the new Ledstrips are compatible with fast connectors that allow them to be cut and powered at the same time, without the need for tools, as an alternative to traditional soldering – offering maximum speed and ease of installation while maintaining performance. They can be configured in various ways to create luminous geometries, either with adhesive backing or mounted on aluminum profiles.

EFFICIENCY UP TO 135 lm/W

TOOL-FREE INSTALLATION

CUT & FAST CONNECT

MULTIPLE CONFIGURATIONS

UNDERSCORE LED STRIP HIGH POWER

L5 mt
5W - 690 lm/m
10W - 1350 lm/m
15W - 1950 lm/m
20W - 2560 lm/m
2200K 2700K 3000K
3500K 4000K
CRI 90
IP20
DALI-2
ON-OFF
Quick-Fit Connectors

UNDERSCORE LED STRIP TUBE HIGH POWER

L5 mt
5W - 640 lm/m
10W - 1250 lm/m
15W - 1860 lm/m
20W - 2360 lm/m
2200K 2700K 3000K
3500K 4000K
CRI 90
IP65 (if the strip is uncut)
DALI-2
ON-OFF

Intelligent Light Solutions

Smart Control: Organic Response |
Quick BLE (Casambi) | Quick DALI |
Master Pro EVO
Smart Services: Space Management |
Push Notification



Available from June 2025





RIBEIRA

A gentle presence

design David Chipperfield

Designed by David Chipperfield, Ribeira is based on an idea of essential form where compactness becomes a design choice. A pure volume, reduced, thinned, simplified, finding a balance between presence and discretion, preserving the circularity and softness of the whole. A measured subtraction creates a central void that enhances the elegance of the form. Along the circular crown, the miniaturised Optidiamond optic is discreetly embedded, emitting a soft, even light. Aesthetics and performance come together: available in transparent white or black, in flush and frame versions, with a distinctive effect even when switched off. The No Dot version generates a continuous ring of light; the Optismart optic allows asymmetrical distributions. Fully disassemblable, designed to last, to be repaired, to stay.



EFFICIENCY
UP TO 125 lm/W

COMPACT DESIGN

**COORDINATED
SYSTEM**

**SILICONE-FREE,
FULLY DISASSEMBLED
AND RECYCLABLE**

RIBEIRA

Ø150mm – Ø210mm

Ceiling | Wall Mounted | Bollard

M | F | WF | No Dot | A60 | ST 1.5

Opti Diamond black transparent

Opti Diamond white transparent

Opti Smart Lens

No dot

2700K | 3000K | 3500K | 4000K

CRI 80

From 900 to 2400 lm

Up to 125 lm/W

IP66 | IK06 (Ø150) IK08 (Ø210) |

Class I (Ø150) Class II (Ø210)

DALI-2

CASAMBI

Intelligent Light Solutions

Smart Control: Quick BLE (Casambi)

Quick DALI | Master Pro EVO

Smart Services: Push Notification



Available from September 2025





Ribeira is a gentle presence that inhabits outdoor spaces with a welcoming light that promotes wellbeing. Available in ceiling, wall or bollard versions.





PATENTED OPTIDIAMOND TECHNOLOGY

Even outdoors, for outstanding brilliance, visual comfort and high efficiency. Flush and frame.

DISASSEMBLABLE, RECYCLABLE AND REPAIRABLE

Without silicones, the product can be completely disassembled and therefore recycled in its entirety.

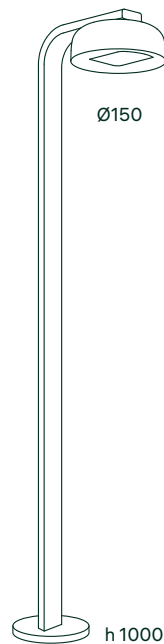
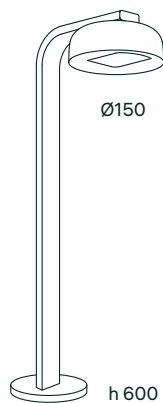
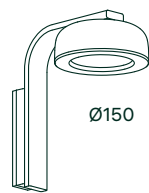
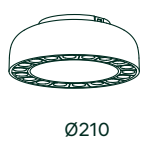

-  WHITE
-  BLACK
-  GREEN
-  GREY
-  RUST BROWN



Ceiling

Wall Mounted

Bollard



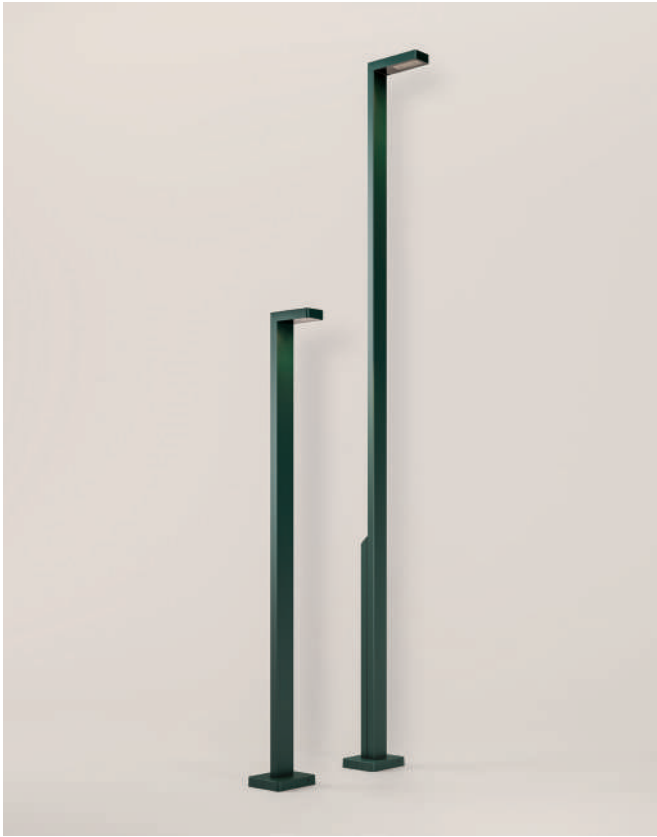

LANDER

New versions: new optics and heights

design Renzo Piano Building Workshop

Lander expands with two new versions, extending its applications to urban environments. Designed by Renzo Piano to illuminate the Stavros Niarchos Foundation park in Athens, it stands out for its minimal, elegant, and versatile design. The Optismart lens technology ensures efficiency up to 120 lm/W, with street, symmetric and asymmetric distributions, ideal for urban paths, parks, bike lanes, and residential or hospitality settings, with poles of 4m or 2.5m. Smart versions with Zhaga socket technology are suited for urban contexts, while Casambi-controlled versions are ideal for residential applications. The new versions with Optismart lens optics complement those with Optismart reflector in the bollard models, which include a wall washer distribution. A wall-mounted version with direct and indirect light completes the range. Solid structure, designed to withstand vandalism.

8 NEW OPTICS

COMPLETE RANGE

ZHAGA SOCKET

EASY MAINTENANCE

LANDER

271x126mm H=2500mm
355x126mm H=4000mm
A60 ST1U ST1.5U STCy0.5 ST1.5
STWt1 STWt1.5 SMC
Opti Smart Lens
2200K 2700K 3000K 4000K
CRI 70 CRI 80
Up to 4000 lm

Up to 120 lm/W
IP66 IK09
Class II H=2500mm
Class III H=4000mm
DALI-2
CASAMBI
Zhaga

Intelligent Light Solutions

Smart Control: Citygrid 3rd party
Quick BLE (Casambi)
Quick DALI Master Pro EVO
Smart Services: Citygrid Portal - TALQ
Push notification



Available from November 2025





OPTISMART TECHNOLOGY

Reflectors with high efficiency and homogeneous light distribution.



TONE ON TONE

The base cover, in the same finish as the product, adds a stylish detail.

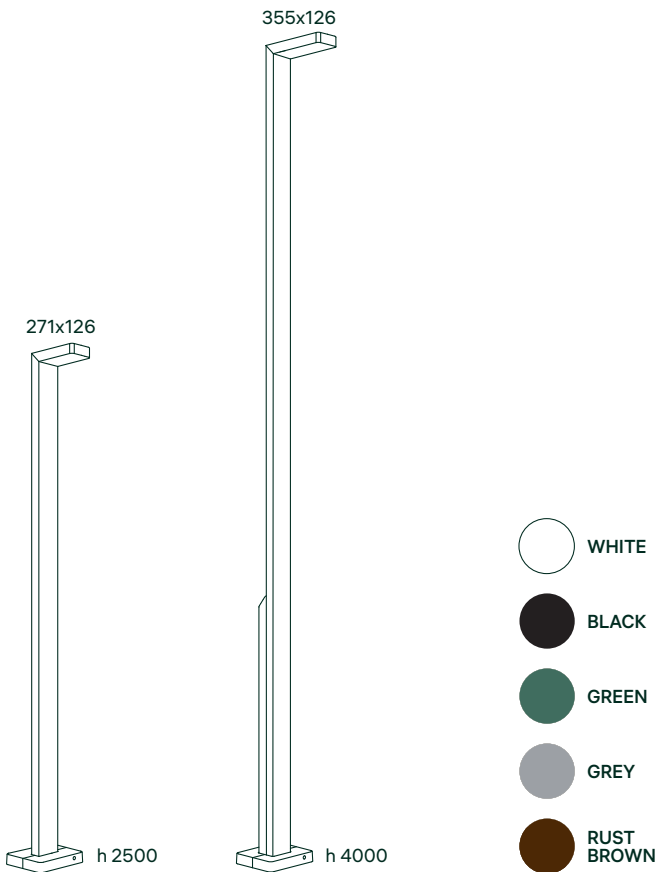



BILLBOARD

Easy refurbishment

design iGuzzini

Billboard is the ideal solution for lighting urban and country roads, designed to ensure both efficiency and safety. A new, larger size is now available to expand the offering. Thanks to its road optics and high efficiency (over 171 lm/W), it provides optimal lighting with reduced energy consumption. Available in a middle-of-the-night version and with a Zhaga socket for remote control and customized management. Easy to maintain thanks to top opening with quick, secure clips requiring no tools. It is 30% lighter than similar products, yet resistant to impacts, external agents, and overvoltages. Ideal for refurbishment projects, with a competitive TCO and tangible benefits in terms of sustainability and energy savings.



EFFICIENCY
UP TO 171 lm/W

EASY MAINTENANCE

ZHAGA SOCKET

COMPETITIVE TCO

BILLBOARD

450x209mm | 516x259mm

STM | STW | ASF

3000K | 4000K

CRI 70

From 2500 to 20000 lm

Up to 171 lm/W

IP66 | IK10 | Class II

Zhaga

Middle of the Night

Intelligent Light Solutions

Smart Control: Citygrid | 3rd party

Smart Services: Citygrid Portal - TALQ

citygrid

Available from November 2025





ZHAGA SOCKET

To connect the pole to a digital network, optimising management and consumption.



ON-SITE MAINTENANCE

Hinged opening and quick-release springs, tool-free.

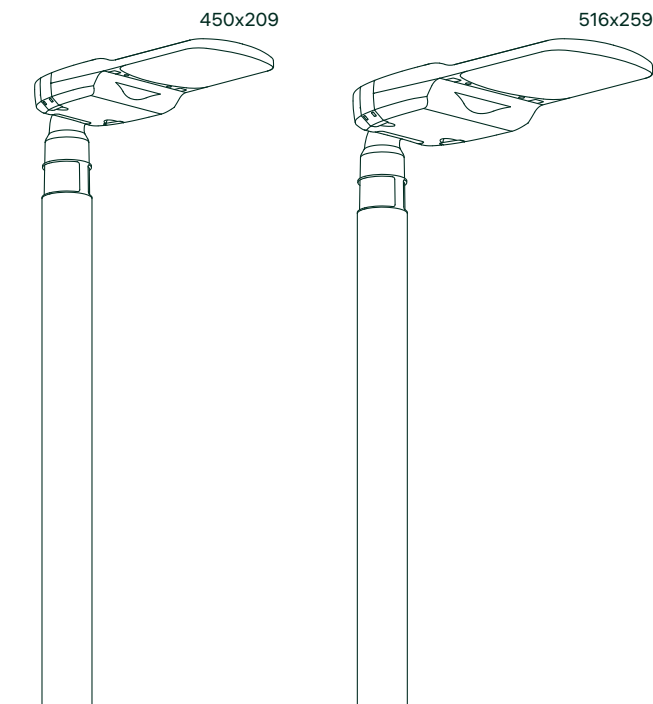

SMART LIGHT CONTROL— 3 LEVELS OF CONNECTIVITY

1 PLUG&PLAY

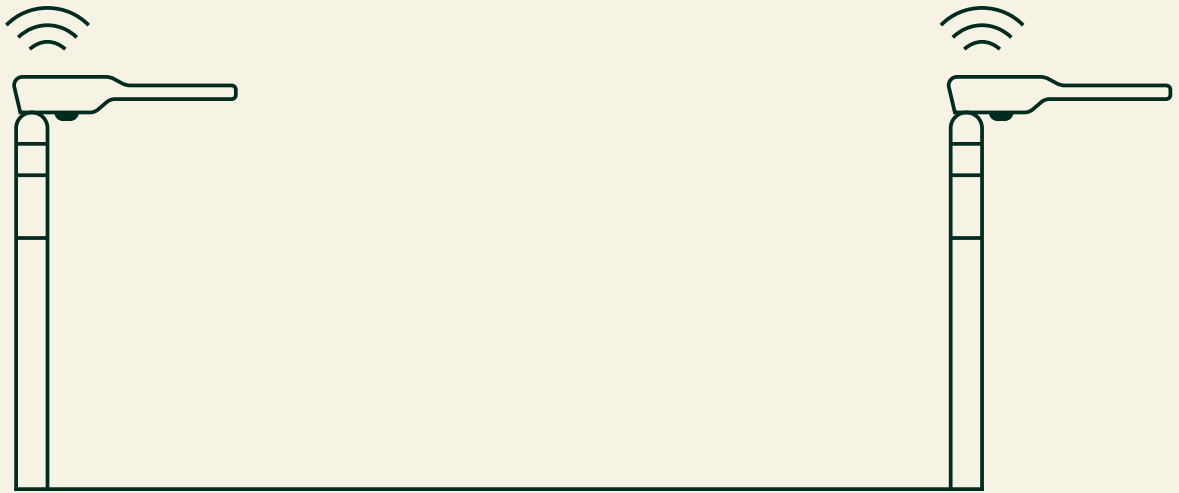

2 CUSTOM SETTINGS

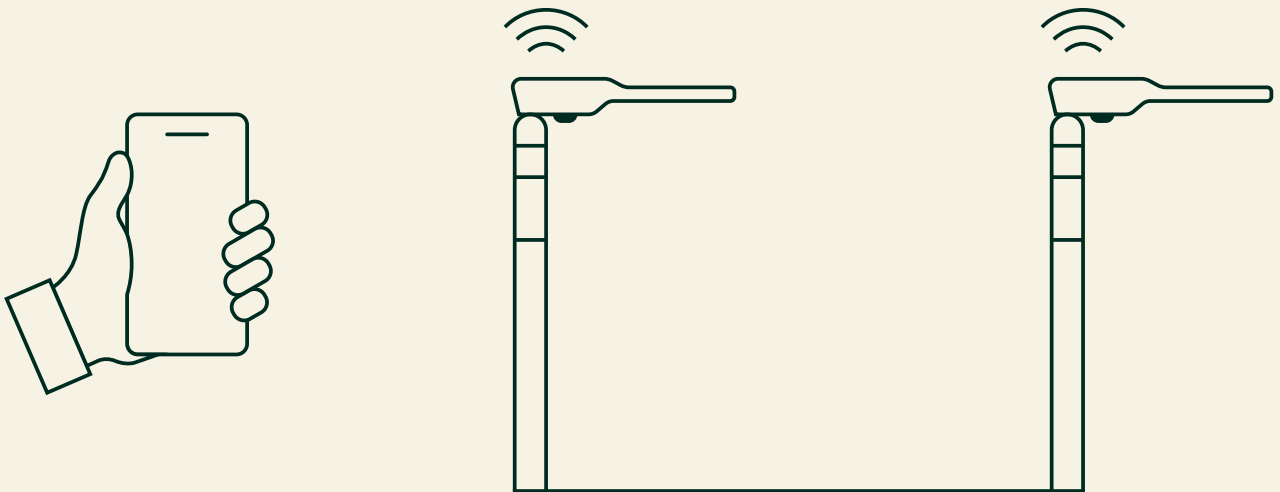

3 CONNECTED

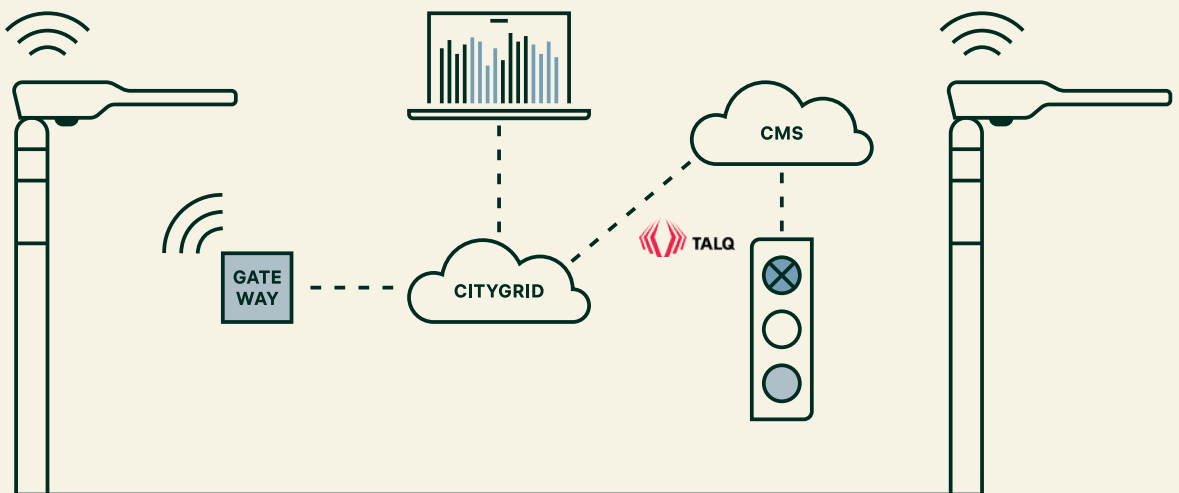

**LIGHT
THAT MOVES**

Creative Direction: 2x4 Inc.
Art Direction: dogtrot
Graphic and Set Design: dogtrot
Render: iGuzzini / Salaposa
Print: Nava Press

Image credits:

p. 12:
Cologne Historical Archive
– Cologne, Germany
Photo: Hans-Georg Esch

p. 13:
Under. Europe's first underwater restaurant
– Lindesnes, Norway
Photo: Tomasz Majewski

p. 14:
Private residence in Manly
– Sydney, Australia
Photo: Rohan Venn

p. 15:
Villa Brattlie
– Nesøya, Norway
Photo: Tomasz Majewski

p. 31:
Belfius Art Gallery
– Brussels, Belgium
Photo: Philippe van Gelooven

